

GEEPHON

BNC-P Series 24/7

Professional displays in 32", 43", 50", 55", 65" and 75" sizes,
perfect for public spaces



easyJet
holidays

FIND YOUR PERFECT PACKAGE HOLIDAY IN EGYPT

Like an open-air museum, nowhere on earth packs in jaw-dropping sights like Egypt does. As well as being the home of iconic landmarks like the Pyramids of Giza, you can expect sun-soaked sandy beaches, rolling dessert dunes, and some of the best snorkelling and diving spots in the world.



Book in-store today
with just a £60pp deposit.



ABTA
The Airline Association
of Great Britain
ABTA No. 196003

egypt

Delivering the ultimate viewing experience in public spaces with our full metal body design, GEEPHON's displays seamlessly integrate into any digital signage environment. With higher brightness, they make a greater impact in transportation hubs, restaurants, command centers, corporate offices, and leisure venues.

Clear information sharing

Elevate your visual experience with our new 4K high-haze panel featuring 700 nits brightness. The GEEPHON BNC-P Series offers pre-calibrated, wide color gamut panels for exceptional color capabilities. Customize your display with modular options to meet your unique needs and applications.

Our displays boast a durable full-metal chassis for professional use, combining robustness with sleek aesthetics to keep the focus on your message. Enjoy seamless connectivity with dual LAN ports for reduced cabling and enhanced daisy-chain capabilities.

Perfect for high-end digital signage in restaurants, command centers, retail, museums, and corporate environments, the GEEPHON BNC-P Series delivers unmatched performance and clarity.

Pre-calibrated color temperature

All BNC-P Series displays come with three preset color temperature options—Standard, Cool, and Warm. This ensures consistent optical performance across all screens, regardless of size or production date.

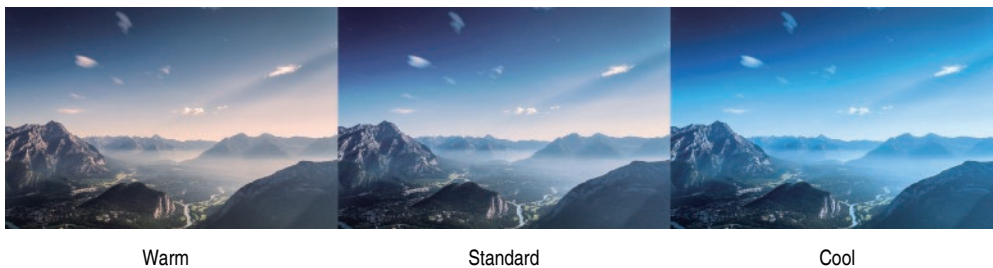

Warm

Standard

Cool

High-End UHD Picture Quality



Experience stunning clarity and vibrant visuals with the entire P Series lineup, supporting native 3840 x 2160 (1920 x 1080 for 32" and 43" series) resolution and HDR compatibility. Elevate your imagery and messaging to new levels of realism and impact!

Maximum Durability



Our full metal chassis provides exceptional fire resistance and robust durability, ensuring your product remains safe and secure during installation and maintenance.



Robust Daisy Chain Capabilities

BNC-P Series displays support direct daisy chaining of HDMI and LAN inputs. Geephon's daisy chain is particularly beneficial in environments where multiple displays are needed and where reducing cable clutter, simplifying setup, and maintaining consistent performance are priorities. It's a feature that enhances both practicality and aesthetics in multi-monitor setups, perfect for menu board and retail application.

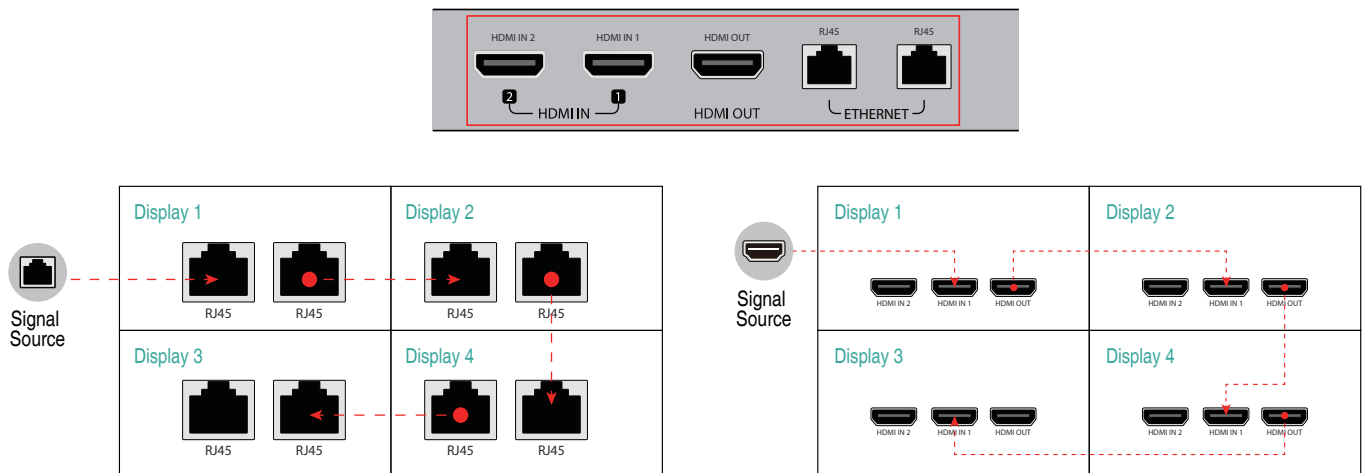

Multi Picture Mode

GEEPHON BNC-P Series displays feature Multi Picture Mode, allowing multiple simultaneous images with individualized color settings. Optimize each section of your display for different content types effortlessly.

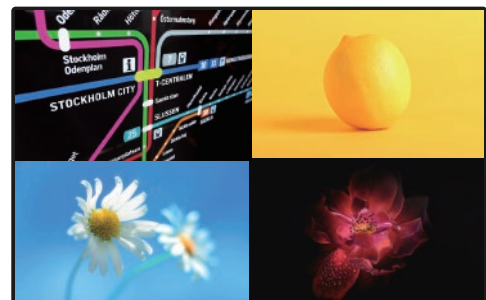

MSC Get

Experience seamless control with our all-in-one remote support software for GEEPHON displays. This central solution offers monitoring, asset management, and control functionality, perfect for managing multi-device installations. Easily handle tasks, generate reports, and control your entire GEEPHON ecosystem on demand. Available for both Desktop and Android mobile, this free optional software ensures efficient and effective management of your display network.

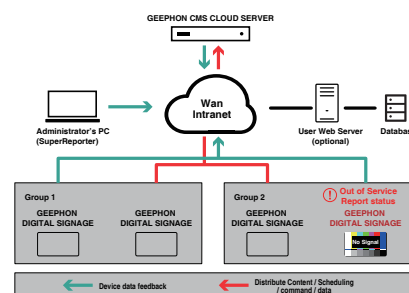

Fail Over Functionality

This feature lets customers prioritize up to 2 inputs, ensuring the display automatically switches to the next preferred source if the primary one fails. The "first detect" option enables the display to automatically activate with any connected source, waking up on any synced signal.

Typical Series

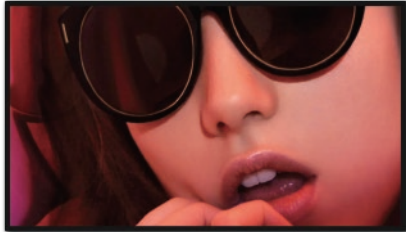

If the source fails, this results in a blank screen

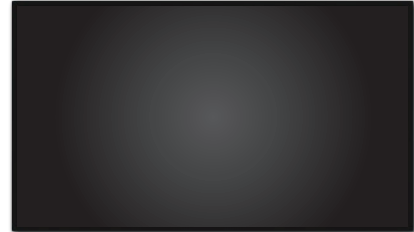

BNC-P Series

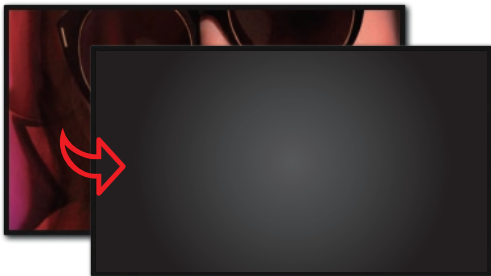

AUTOMATIC

If the source fails, the display auto-switches to the next prioritized source, meaning zero down time on the display.



First Detect



AUTOMATIC

Setting the display to First Detect allows the display to automatically turn on when any source is plugged into it.



BNC6523A-AA-07P

65" | 4K - Edge LED | 700 cd/m² | IPS panel with anti-glare and higher haze | 24/7 (MTBF = 50 000hrs)
Android SOC | 2.4G/5G Wi-Fi with BT | Super slim & narrow Bezel 10mm | Failover | IP 5X protection level

Specification

BNC6523A-AA-07P

Hardware Specification

Panel	IPS
Display Size	65 inch
Protection Glass	N/A
Protection Level	IP 5X (Front Panel)
Front Color	Black
Set Dimension (L*W*D)	1450.28 x 825.32 x 55.4mm
Bezel Width Width(mm)	9.9mm
Active Display Area(H*V)	1428.48 x 803.52mm
Resolution	3840 x 2160
Type	60Hz E-LED BLU
Brightness(Typ.)	700 cd/m ²
Contrast Ratio(Typ.)	1200:1
Haze	25%
Viewing Angle(H/V)	178°(H) x 178°(V)(CR≥10)
Display Colors	1.07 G
Color Gamut	68%
Response Time	8ms (Typ)
Operation Hour	24/7
Smart Solution	PTC.DT1AHE-BAB
Connectivity	USB2.0*2, HDMI In*2, HDMI Out*1, Ethernet(RJ45)*2, RS232(RJ45)*1, Line Out*1, Sensor*1, IR In*1
Power Input Supply	100-240V AC, 50/60Hz
Power Consumption	230W
Speaker	8W/8Ω *2
IR	External connection
Touch Technology	N/A
Camera	N/A
Installation	Wall mount
VESA Mount	400 x 400mm
Package(W*H*D)	1611 x 978 x 180mm
Weight (kg)	N.W: 20.5kg G.W: 31kg
Operating Temperature	0°C~+40°C
Storage Temperature	-10°C~+60°C

System Specification

CPU	ARM Quad Core Cortex-A53 1.5G
GPU	ARM Mali-G52 2EE MC1
Operating System	Android 9
Cloud Advertising	Optional
Distribution System	Optional
Cloud Splice System	Optional
Memory	DDR 2G
Storage	EMMC 16GB
Ethernet	Ethernet (RJ45) WiFi 802.11b/g/n 4G LTE(FDD/TDD)(Optional)
Panel Image Rotation	0/90/180/270/360 Angle Rotation
Video Decoder	MPEG-1/2/4, H.264, HEVC, VP8, VP9, AVS+, AVS2, AV1
Audio Decoder	MPEG-1, MPEG-2(layer I/II), MP3, AAC-LC, HE-AAC
Picture Decoding	JPG, JPEG, PNG, BMP

What's in the box

Power Cable	x 1 Power cord (based on region)
Remote Controller	x 1
RS232 Adaptor	x 1

Warranty

Warranty	Three year or by contract
----------	---------------------------

Dimensions

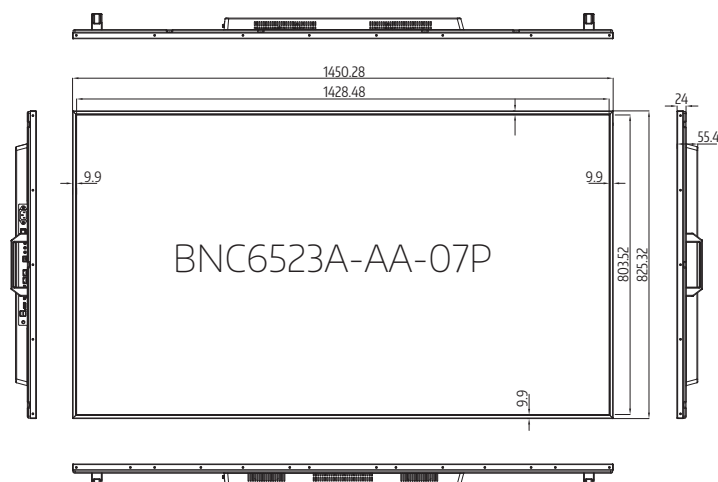

Unit: mm

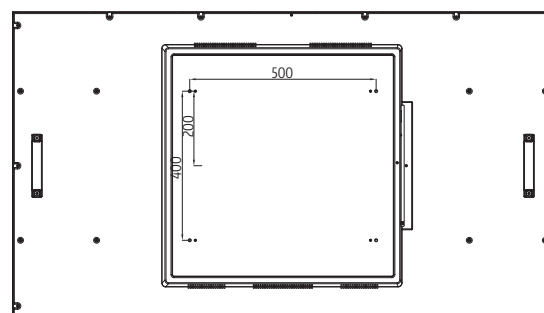

CONNECTIVITY

